

From Eye to Insight

Leica
MICROSYSTEMS

Educational Compound Microscopes

A NEW GENERATION'S CHOICE OF INNOVATIVE EDUCATIONAL MICROSCOPES

Leica DM500 & DM750



MADE FOR FUTURE NOBEL PRIZE WINNERS

Science Teaching Revitalized

The more time the instructor has to teach, the more students can learn. The Leica DM500 and Leica DM750 microscopes were specifically developed to revitalize science teaching and to achieve the goal of more hands-on time for Life Science courses. With many student-friendly features and high-quality construction, the Leica DM500 and Leica DM750 invigorate science learning and teach the next generation of scientists effectively and efficiently.

SUPERB OPTICS

- › Based on the same optical platform as Leica Microsystems' research microscope line, students enjoy outstanding optical performance with full access to virtually all accessories from Leica's microscope product line.
- › NEW! 100× dry (no oil needed) objective provides very high resolution (N.A. 0.8) while eliminating the need for oil.

EZLITE™

- › LED illumination provides cool, white light with a lifetime of over 20 years average use. There is no need to change lamps during lab time, and this saves the expense of replacement lamps as well.
- › The cost-savings pays for several microscopes over their lifetimes.

SAFETSTAGE™

- › Microscope stage maintains its dimension, which eliminates the chance of injury from contact with a conventional stage rack.
- › Rounded edges are easy on the skin.

EZSTORE™

- › Integrated vertical handle provides easy carrying and lifting when storing on high shelves; undercut on front of stand works in combination with the handle for safer, two-handed carrying.
- › Integrated cord wrap eliminates damage to microscope components from improper cord wrapping; vertical cord insertion prevents the cord from pulling partially out of the stand while in storage or in use.
- › The unique shape of the microscope stand protects controls from damage when microscopes are stored side-by-side.

EZGUIDE™

- › Student friendly slide holder helps prevent slide chipping

USB POWER CONNECTOR

- › Providing power to the Leica USB cameras is extremely easy. Simply connect the camera via the provided USB cable to the 5 V/1.5 A USB power connector on the rear of the Leica DM500 and Leica DM750 stand. This saves the cost of an external power supply for the camera plus reduces the complexity at the workstation.

AGTREAT™

- › The possible contamination with germs from surfaces is of great concern, especially in educational environments. Leica Microsystems has integrated an additive to the material of all microscope touchpoints to inhibit the growth of bacteria. This helps prevent the spread of disease via the microscope surfaces and leads to a healthier laboratory environment.



LEICA DM500 – SCIENCE TEACHING MADE EASY

The Leica DM500 is ideal for entry level Life Science courses. The microscope's stand provides "plug and play" capability. All students need to do is turn the power on, place the specimen slide on the stage, focus, and enjoy the view!



READY TO WORK

- › Pre-centered, pre-focused Abbe condenser eliminates the need for adjustments



EZTUBE™

- › Eyepieces integrated with the eyetubes prevents loss
- › Preset diopter adjustments eliminates the risk of incorrectly setting the diopters
- › Other viewing tubes are also available



SAFER ROTATION

- › Captive thumbscrew for safer rotation of the EZTube™



ALL IN ONE

- › Abbe Condenser with slot for phase contrast and darkfield sliders, including a 4 position phase slider, which offers brightfield and phase capabilities all in one slider

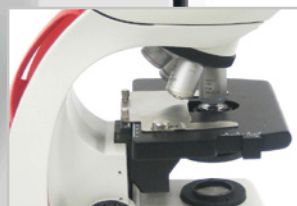

PERFECT LIGHT

- › LED illumination designed to provide even lighting across the full field of view without adjustments

LEICA DM750 – SCIENCE TEACHING FOR A NEW GENERATION

The Leica DM750 is designed specifically for the versatile needs of advanced Life Science courses and for professional training such as medical, veterinary, and dental schools.

VERSATILE

- › Standard condenser for magnifications 4× – 100×
- › Phase turret condenser for brightfield and phase contrast
- › Flip top condenser for low magnifications
- › The Leica DM750 is available with a 4 position or 5 position nosepiece



WEAR RESISTANT

- › Special stage finish offers additional protection from friction damage

ENERGY SAVING

- › Time delay shutoff saves energy by automatically turning off the illumination after 2 hours of no use



A+ FOCUS, CONTRAST & ILLUMINATION

- › Weighted focus knobs provide inertia and extremely accurate focus capability
- › Koehler field diaphragm available as an option for optimum illumination and contrast



SHARED VIEWING MADE EASY

- › Variety of viewing tubes provides free rotation while securely fixed to the stand
- › Standard viewing tubes with eyepiece locking screws prevent loss of eyepieces

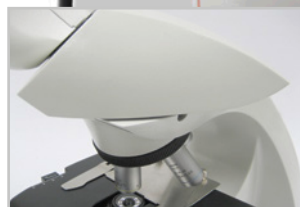

GO WIRELESS!

The ability to share, capture, and archive images is an important part of the microscopy laboratory. The Leica DM500 and Leica DM750 are compatible with the full range of Leica Microsystems imaging solutions, allowing you to select the camera which best suits the demands of your classroom. Keep students on topic and maximize learning time with the NEW Leica ICC50 W/ E High Definition Wireless camera module.

THE ICC50 W/ E CAMERA MODULE – INTEGRATED & MODULAR

- › In Ethernet mode, the connection to the camera is provided through your own network, allowing a maximum number of users to connect to the camera. To use this to full extent, all devices have to be on the same network as the microscope.
- › In USB mode you can connect your PC directly via USB cable to the camera, which is helpful when you aim for the fastest live images e.g. of moving samples.
- › Computer users can use the Leica Imaging software to connect to the camera and work with the images. For PC use Leica Application Suite software, and use Leica Acquire for MAC.
- › Use lots of options with Leica AirLab App: It enables camera setup, annotations, measuring, image capture, and sharing to email, photo folders, or other social media connections.
- › Leica AirLab App is available free of charge for Android and iOS devices.
- › Stay flexible if there is no PC or mobile device around: Just capture images directly onto a memory card.
- › Fine-tune camera settings conveniently, capture images onto the SD card, and view the SD card gallery – all possible with the remote.
- › Project your images: Use the HDMI port for screen projections or output to HD screens.
- › You don't need any extra power cables: The camera is powered directly from the microscope stand with a USB cable.

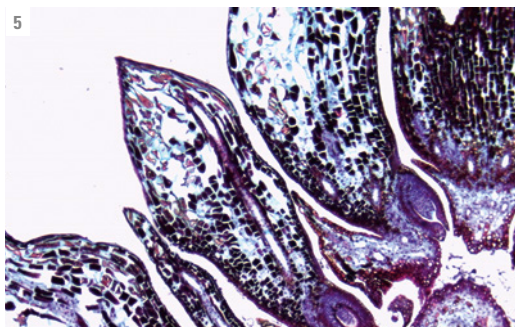
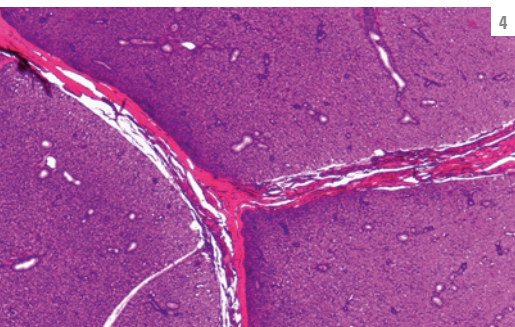
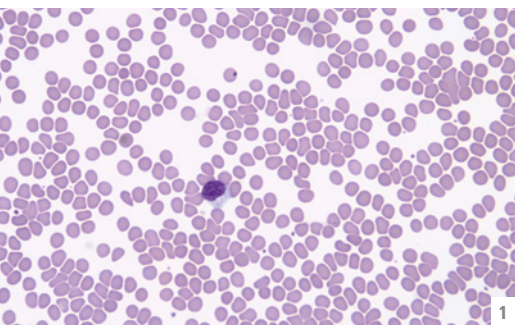



Students can connect to the Leica ICC50 W either through its own **internal Wi-Fi signal** using Wi-Fi mode or through the facilities' network using Ethernet mode.



The ICC50 E **exclusively** uses your facilities' **network (WLAN or LAN)** to allow students to connect to the camera. This is an ideal solution if you don't want to add additional Wi-Fi access points to your network.

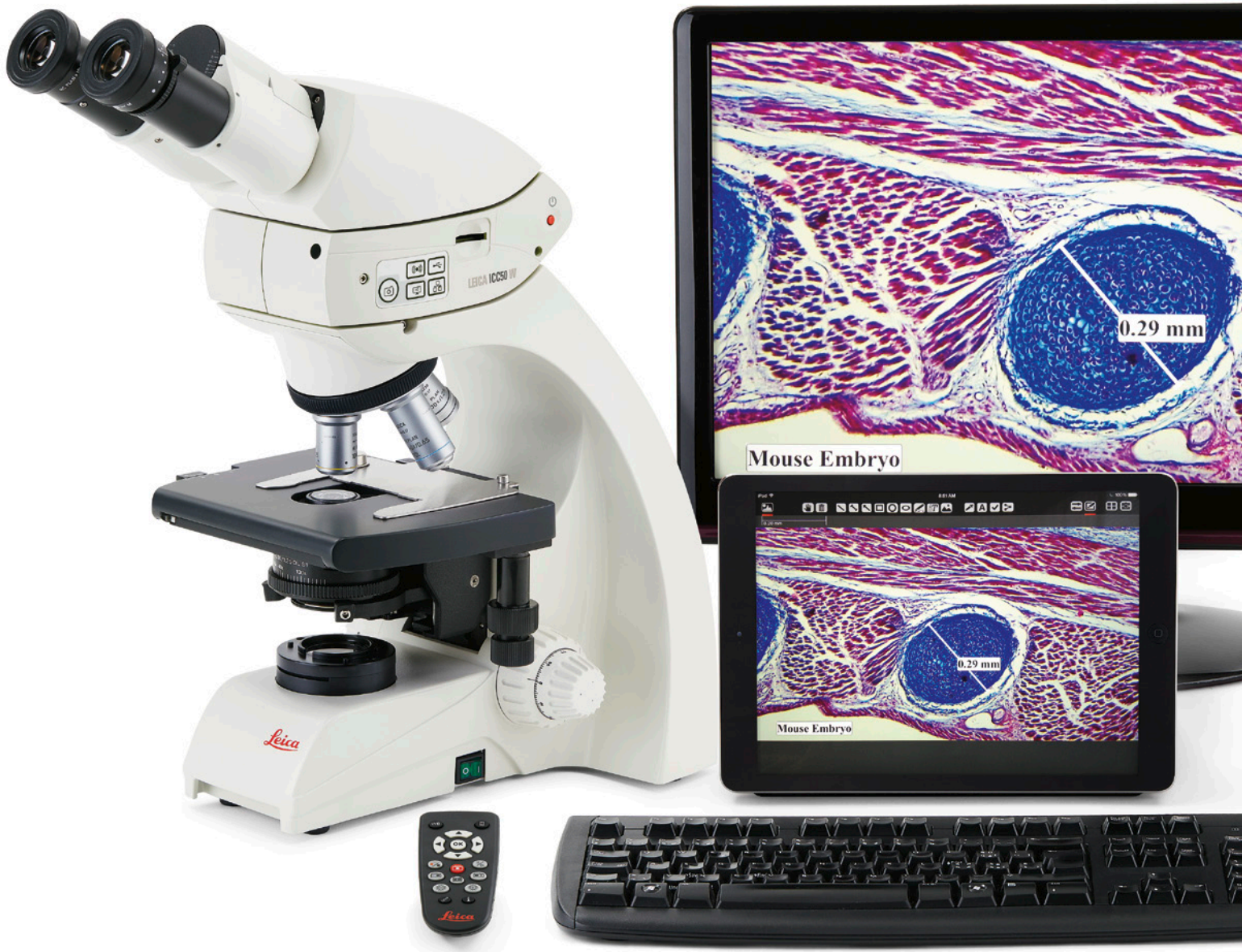

- 1: Human Blood
- 2: Convallaria – Lily of the Valley
- 3: Giant Chromosomes
- 4: Parotid Gland
- 5: Pine
- 6: Taste Buds

Leica DM750 with Leica ICC50 W digital microscope camera

SYSTEM DIAGRAM

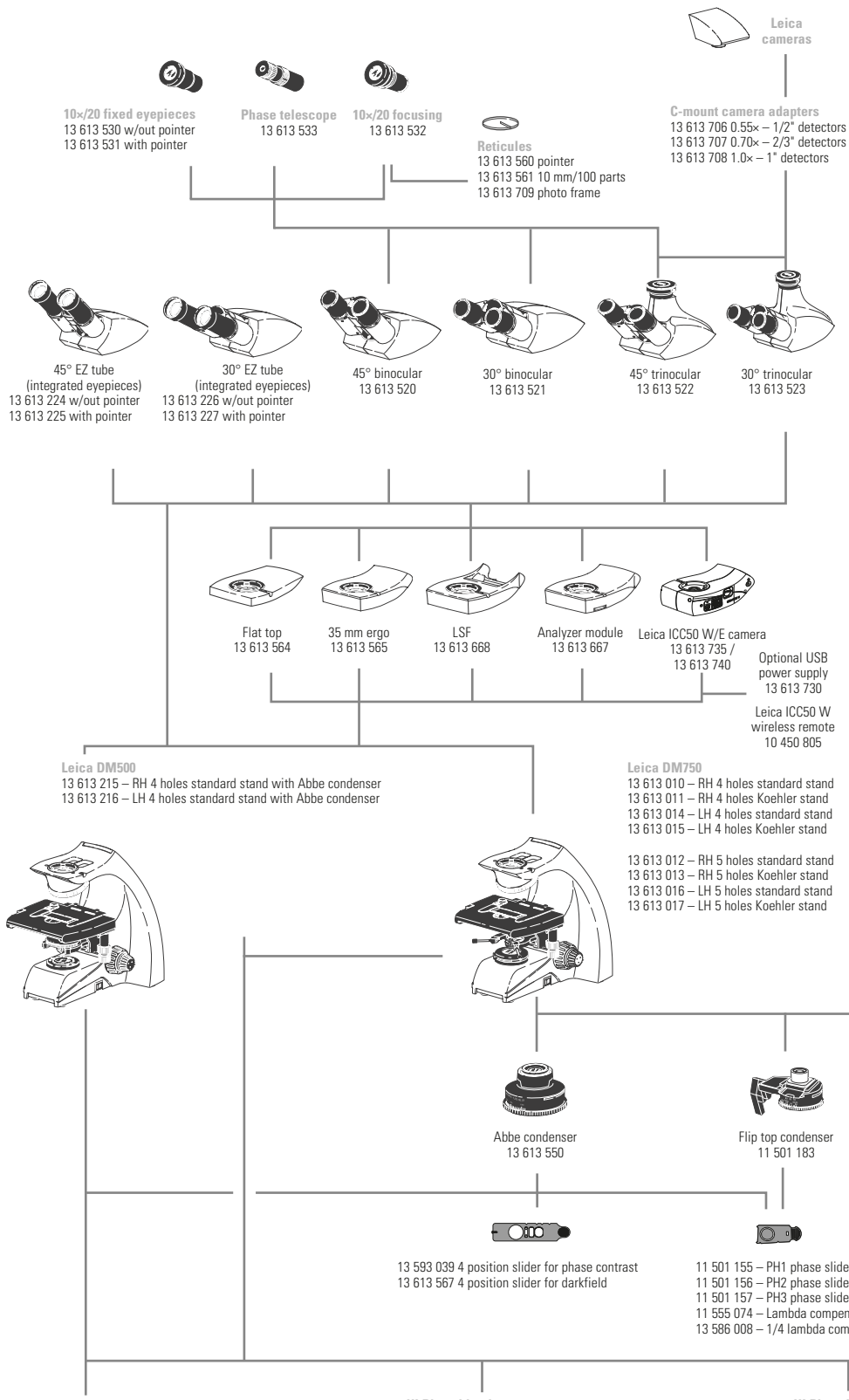

- 13 613 563
- 13302138946910
- 13 613 571
- 13 613 572
- 13 613 584
- 13 613 210-100
- 13 613 510-100
- 13 613 735-100
- 13 613 573

Replacements
 Eyeguard pair
 Fuses for Leica DM500, Leica DM750
 Thumbscrew pair for Leica DM750 condenser mount
 Set screw pair for Leica DM750 condenser mount
 Dust cover Leica DM500, Leica DM750
 Leica DM500 User documents
 Leica DM750 User documents
 Leica ICC50 W user documents
 Add-on lens for condensers for Leica DM750 (included with stand)

- 11 555 045
- 11 555 079
- 11 555 080

Analyzer module sliders
 Fixed analyzer slider
 180° rotatable analyzer slider
 360° rotatable analyzer slider

- 13 613 262
- 13 613 261
- 13 614 800
- 11 513 106
- 11 505 091
- 11 505 507

Others
 Captive thumbscrew for EZ tube
 Rubber grips for X/Y controls
 Immersion oil
 Stage micrometer
 Diffuser slider for using 2.5x objective with Abbe condenser
 Auxilliary lens for using 2.5x objective with 11 501 183 flip top condenser
 32 mm filter holder
 Hard carrying case
 Soft carrying case
 Simple pol kit

- 13 613 900
- 13 613 901
- 13 613 902
- 13 613 903
- 13 613 904
- 13 613 905
- 13 613 906
- 13 613 907
- 13 613 908
- 13 613 909
- 13 613 910
- 13 613 911
- 13 613 912

International power cords
 U.S.
 Europe Continental
 U.K.
 Switzerland
 Denmark
 Italy
 Australia
 China
 Japan
 Israel
 South Africa
 India
 Argentina

Plan objectives
 13 613 240 - Plan 4x/0.10 NA, 26.2 mm*
 13 613 241 - Plan 10x/0.22 NA, 7.8 mm*
 13 613 242 - Plan 40x/0.65 NA, 0.31 mm*
 13 613 243 - Plan 100x/1.25 NA, 0.10 mm*, oil
 * working distance

HI Plan objectives
 11 506 226 - HI Plan 4x/0.10 NA, 18.0 mm*
 11 506 228 - HI Plan 10x/0.25 NA, 12.0 mm*
 11 506 276 - HI Plan 20x/0.40 NA, 0.92 mm*
 11 506 236 - HI Plan 40x/0.65 NA, 0.36 mm*
 11 506 237 - HI Plan 63x/0.75 NA, 0.31 mm*
 11 506 238 - HI Plan 100x/1.25 NA, 0.10 mm*, oil
 11 506 322 - HI Plan 100x/0.80 NA, 0.3 mm* dry objective
 * working distance

HI Plan phase objectives
 11 506 230 - HI Plan phase 10x/0.25 NA, 12.0 mm*
 11 506 278 - HI Plan phase 20x/0.40 NA, 0.92 mm*
 11 506 240 - HI Plan phase 40x/0.65 NA, 0.36 mm*
 11 506 241 - HI Plan phase 100x/1.25 NA, 0.10 mm*, oil
 * working distance

PRECONFIGURED OUTFITS

OUTFIT ORDERING NUMBER	13 613 207	13 613 208	13 613 403	13 613 406	13 613 001	13 613 004	13 613 002	13 613 005
	DM500	DM500	DM750	DM750	DM750	DM750	DM750	DM750
STANDS								
13 613 215	DM500 RH Stand with Abbe condenser	X	X					
13 613 010	DM750 RH Stand			X	X	X		
13 613 011	DM750 RH Stand Koehler						X	X
TUBES								
13 613 224	45° EZ tube	X		X				
13 613 225	45° EZ tube with pointer		X		X			
13 613 520	45° binocular tube					X	X	X
EYEPIECES								
13 613 530	10×/20 eyepiece w/eyeguard					X	X	
13 613 531	10×/20 pointer eyepiece w/eyeguard						X	X
13 613 532	10×/20 focusing eyepiece w/eyeguard					X	X	X
CONDENSERS								
13 613 550	Abbe condenser 0.9 Dry/1.25 oil			X	X	X	X	X
OBJECTIVES								
13 613 240	Plan 4×/0.10 NA, 26.2 mm W.D.	X	X	X	X			
13 613 241	Plan 10×/0.22 NA, 7.8 mm W.D.	X	X	X	X			
13 613 242	Plan 40×/0.65 NA, 0.31 mm W.D.	X	X	X	X			
13 613 243	Plan 100×/1.25 NA, 0.10 mm W.D., oil	X	X	X	X			
11 506 226	HI Plan 4×/0.10 NA, 18.0 mm W.D.					X	X	X
11 506 228	HI Plan 10×/0.25 NA, 12.0 mm W.D.					X	X	X
11 506 236	HI Plan 40×/0.65 NA, 0.36 mm W.D.					X	X	X
11 506 238	HI Plan 100×/1.25 NA, 0.10 mm W.D., oil					X	X	X
13 614 800	Immersion oil	X	X	X	X	X	X	X

POWER CORD NOT INCLUDED: Must be ordered separately

DIMENSIONS LEICA DM500 / DM750

Dimensions in mm/inch

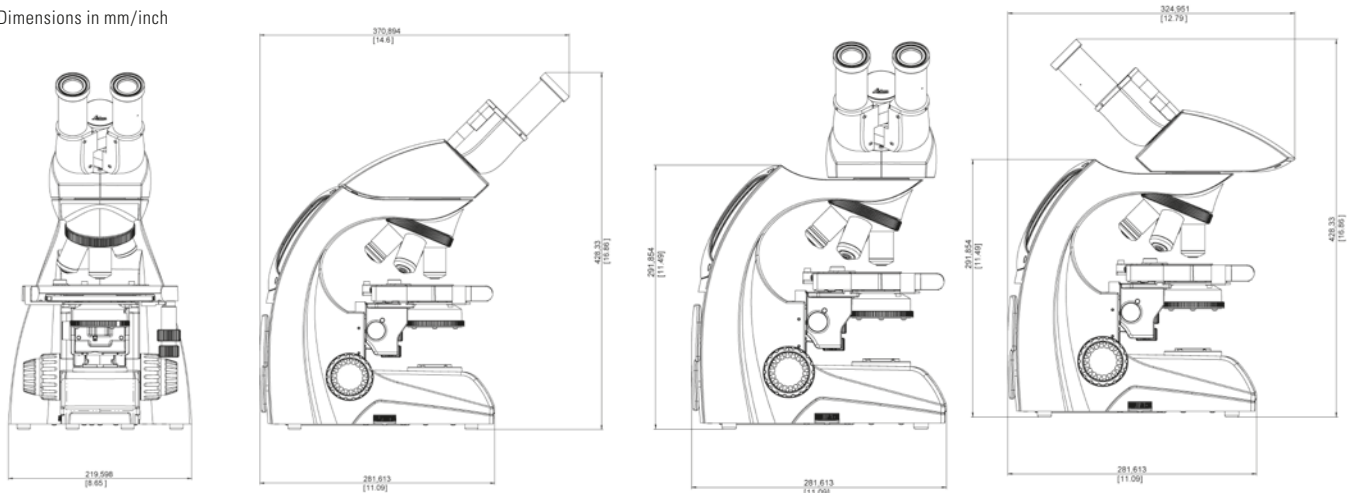

SPECIFICATIONS LEICA DM500 / DM750

	DM500	DM750		DM500	DM750
SEPARATE EYEPIECES			SAFETSTAGE™		
High eyepoint	X	X	Stage surface 185 mm (150 mm front) wide × 140 mm deep	X	X
10×/20 (20 mm field of view)	X	X	Rounded stage edges	X	X
Available with or without pointer	X	X	Non extending rack	X	X
Available fixed or focusing	X	X	Verniers for X/Y coordinates	X	X
Focusing eyepieces with reticule holder for 24.5 mm reticle	X	X	Wear resistant stage surface	X	X
Foldable eyeguards	X	X	CONDENSER		
30 mm mounting diameter	X	X	Prefocused and precentered Abbe condenser	X	
EZTUBE™			Centerable and focusable condenser mount		X
Preset diopters for corrected vision	X	X	Slot in Abbe condenser for contrast sliders (phase, darkfield, compensator)	X	X
45 degree viewing angle	X	X	Magnification labels on condenser	X	X
10×/20 (20 mm field of view)	X	X	Standard Leica condenser mount for condensers (Abbe, turret, flip top, etc.)		X
Attaches to stand with set screw	X	X	FOCUS		
Captive thumbscrew available for safer rotation	X	X	Low position focus controls	X	X
Eyepieces are integrated with tube	X	X	Self adjusting focus mechanism	X	X
Available with pointer and without pointer	X	X	300 microns per fine focus rotation	X	X
Interpupillary distance range 52 mm – 75 mm	X	X	Calibrated in 3 micron increments	X	X
OTHER VIEWING TUBES FOR SEPARATE EYEPIECES			Weighted focus knobs		X
45 degree, 30 degree, trinocular	X	X	EZLITE™		
Maximum field of view 20 mm	X	X	Preset field aperture only	X	
Rotatable dovetail	X	X	Available with or without adjustable Koehler field diaphragm		X
Leica tube dovetail standard	X	X	LED Illumination – 6 000 K temp, 25 000 h life at full intensity	X	X
Eyepiece locking screw	X	X	Continuous intensity adjustment	X	X
Interpupillary distance range 52 mm – 75 mm	X	X	Illumination sufficient for viewing at lowest intensity	X	X
STAND			Simple polarizing kit available	X	X
Stand shape protects controls	X	X	2 hour Auto Off (can be disabled or enabled)		X
Stand construction – die-cast aluminium	X	X	Auto Off default: 4 hole stands enabled, 5 hole stands disabled		X
External fuses	X	X	IMAGING		
Knurled nosepiece	X	X	Trinocular tubes available (50 %/50 % light split)	X	X
4 position nosepiece only	X		C-mount adapters with standard Leica mount	X	X
4 or 5 position nosepiece available		X	Leica ICC50 W intermediate camera module (50 %/50 % light split)	X	X
Drop in holder for 32 mm mounted or unmounted filters	X	X	INTERMEDIATE MODULES		
5 V/1.5 A USB power supply to power camera	X	X	35 mm intermediate ergo module available	X	X
EZSTORE™			15 mm flat top module	X	X
Vertical handle	X	X	Module for LSF reflected light illuminator	X	X
Undercut in front of stand	X	X	Analyzer module	X	X
Cord wrap	X	X	AGTREAT™		
Vertical cord attachment to stand	X	X	Anti microbial treatment	X	X
OBJECTIVES			CERTIFICATIONS		
Infinity optics platform	X	X	cULus, CE, RoHS	X	X
100× dry objective with N.A. 0.8 (no correction collar)	X	X	Main optical components meet ISO 9022-11 for Mould Growth	X	X
Objective labeling laser engraved (HI Plans)	X	X	SHIPPING		
M25 nosepiece thread	X	X	Dimensions: 40 cm × 37 cm × 39 cm (H×D×W)	X	X
EZGUIDE™			Weight: 9 kg	X	X
One-handed slide loading	X	X			
26 mm × 76 mm stage travel	X	X			

CLEAN AND GREEN



WE ACTIVELY IMPLEMENT WAYS TO MAKE OUR ENVIRONMENT
CLEANER AND SAFER FOR THIS GENERATION AND THE NEXT

SEE MORE AT WWW.LEICA-MICROSYSTEMS.COM/EDUCATION

- › All packaging is completely recyclable
- › No lead content in any of the glass components
- › LED illumination consumes approximately 80 % less energy than standard halogen illumination
- › The time delay shut-off feature found on the Leica DM750 ensures no energy is wasted
- › Constantly optimizing our logistics chain keeps the CO₂ footprint as low as possible
- › AgTreat™ helps prevent the spread of disease via microscope surfaces and leads to a healthier laboratory environment
- › All products have been tested by independent safety laboratories and carry the cULus and CE mark to indicate their design for safety
- › All products are RoHs compliant, which means all electrical components meet restrictions on the use of hazardous substances
- › Interactive tour of the Leica DM500 and Leica DM750
- › Leica E-Series stereomicroscopes for low magnification inspection, dissecting, and image capture
- › Leica DM750 P Polarizing Microscope for Earth and Materials Science education
- › Leica DM750 M Microscope for Metallography
- › Selection of higher level microscopes for research
- › A selection of instructional booklets, which are free of charge



Leica Microsystems (Switzerland) Ltd. · Max-Schmidheiny-Strasse 201 · 9435 Heerbrugg, Switzerland
T +41 71 726 34 34 · F +41 71 726 34 44

www.leica-microsystems.com

CONNECT
WITH US!

